

More information on linkedsparx.com
Still need help? Contact us at support@linkedsparx.com



SYRO-Bricks

More Pieces, More Fun

LinkedSparx Technology Co., LTD

Made in China



FCC WARNING

This device complies with part 15 of the FCC Rules. Operation is subject to the following two conditions: (1) this device may not cause harmful interference, and (2) this device must accept any interference received, including interference that may cause undesired operation. Any changes or modifications not expressly approved by the party responsible for compliance could void the user's authority to operate the equipment.

NOTE: This equipment has been tested and found to comply with the limits for a Class B digital device, pursuant to Part 15 of the FCC Rules. These limits are designed to provide reasonable protection against harmful interference in a residential installation.

This equipment generates, uses, and can radiate radio frequency energy and, if not installed and used in accordance with the instructions, may cause harmful interference to radio communications. However, there is no guarantee that interference will not occur in a particular installation. If this equipment does cause harmful interference to radio or television reception, which can be determined by turning the equipment off and on, the user is encouraged to try to correct the interference by one or more of the following measures:

- Reorient or relocate the receiving antenna.
- Increase the separation between the equipment and receiver.
- Connect the equipment into an outlet on a circuit different from that to which the receiver is connected.
- Consult the dealer or an experienced radio technician for help.

To maintain compliance with FCC's RF Exposure guidelines, this equipment should be installed and operated with a minimum distance of 20cm between the radiator and your body. Use only the supplied antenna.

Copyright ©2022 LinkedSparx All Rights Reserved

Designed and Manufactured by LinkedSparx
www.linkedsparx.com

TABLE OF CONTENTS

- What's in the Box? 1**

- App Download 5**

- * MUST READ Before Installation 7**
 - How to count the sequence number of light modules 7
 - How to multiply light effect 8

- How to Create Your Own SYRO-Bricks Layout 9**
 - 1. Display on Stands 9
 - How to Unfasten the Fixture 15
 - Advanced: 3 Ways of Connecting to Stands 16
 - 2. Wall Display 18
 - Advanced: Connect Multiple Groups of Modules 22

- How to Remove Your Layout from Wall 23**

What's in the Box?

1

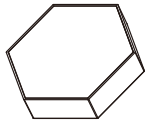

SYRO-Bricks Hexagonal Modules x 16

2

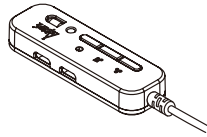

3-Output Controller with 1.5m USB Cable x 1

3

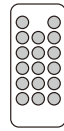

RF Remote Control x 1

4

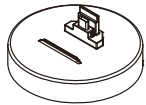

Stands x 2

5

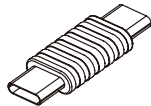

Type-C Connectors x 16 (1 spare included)

6

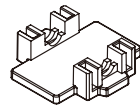

Fixtures x 16 (1 spare included)

7

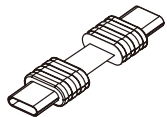

Type-C Flexible Connectors x 1

8

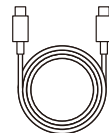

1m Type-C Cables x 2

9

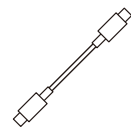

11cm Type-C Cables x 1

10

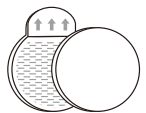

Hook & Loop Adhesive Tapes x 10

11

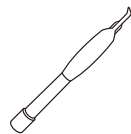

Pry Bar x 1

* The power adapter is NOT included in the kit. You can use a standard 5V USB charger or a power bank. An output of 5V 1~2A is recommended.

SYRO-Bricks Hexagonal Modules

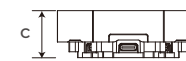
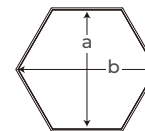
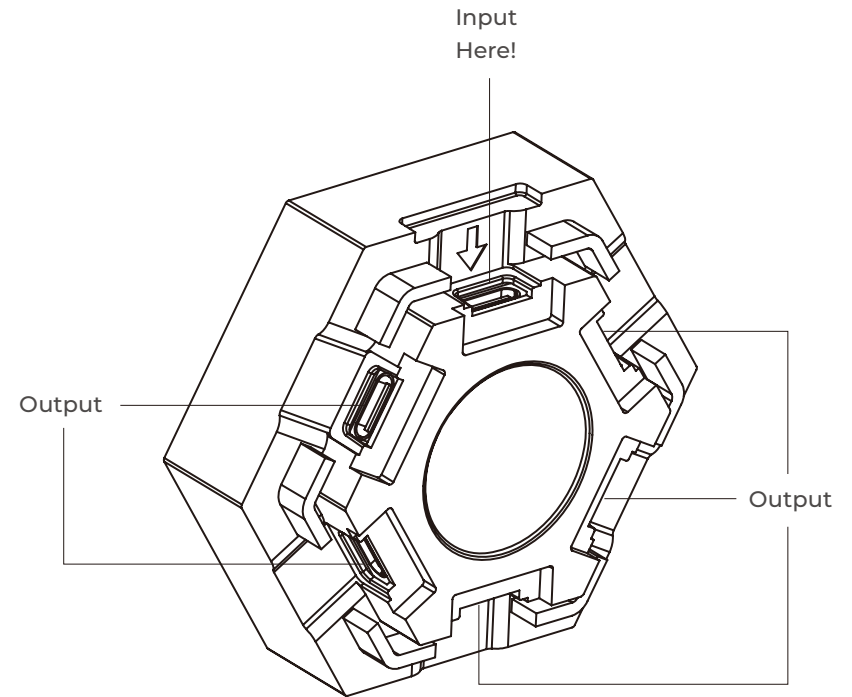

Module Dimensions	
a	6.29cm / 2.48in
b	7.25cm / 2.85in
c	2.4cm / 0.94in

Color: RGB 16 million colors

Connectivity: BT

Working Voltage: 5V/2A

Max Panels Per PSU \approx 100

Max Panels Per Controller on a route: 300

Materials: Fireproof Polycarbonate & ABS

Operating Temperature: -5~45°C

Life Span: More than 20,000 hours

Controller

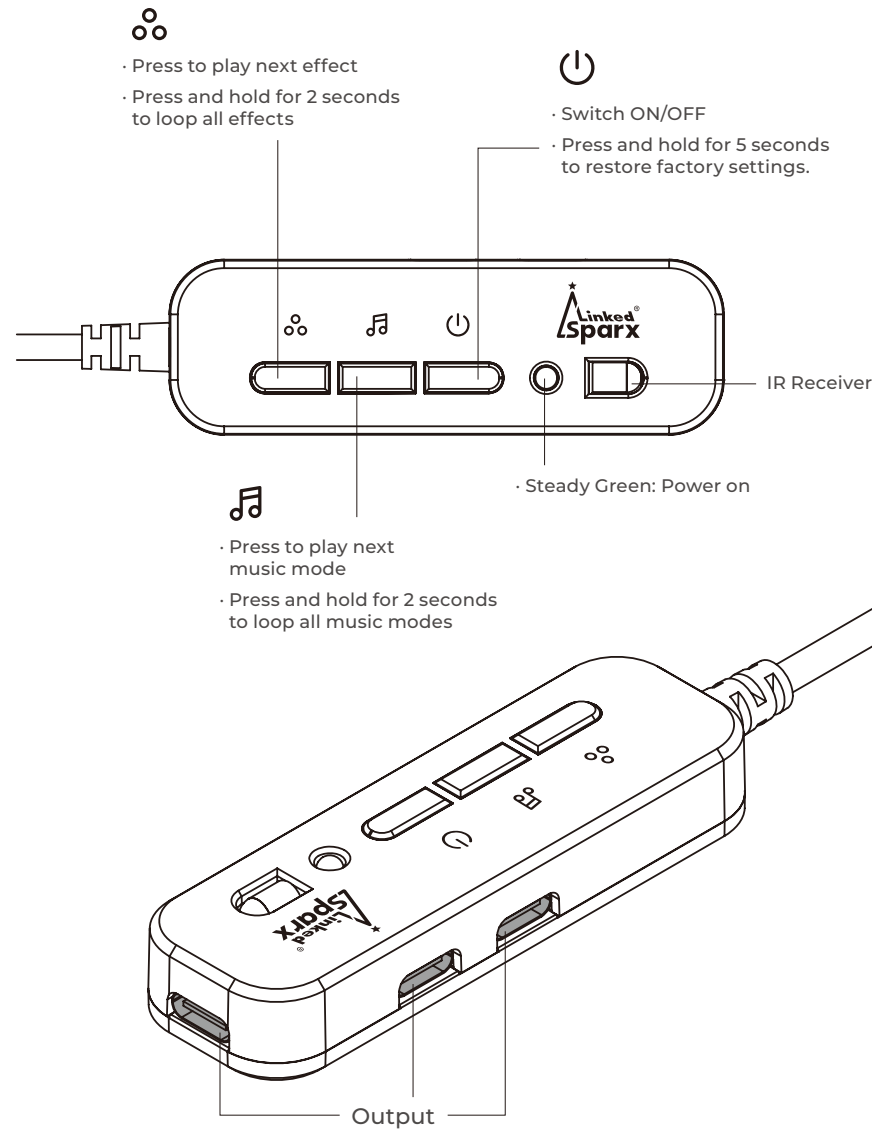

RF Remote

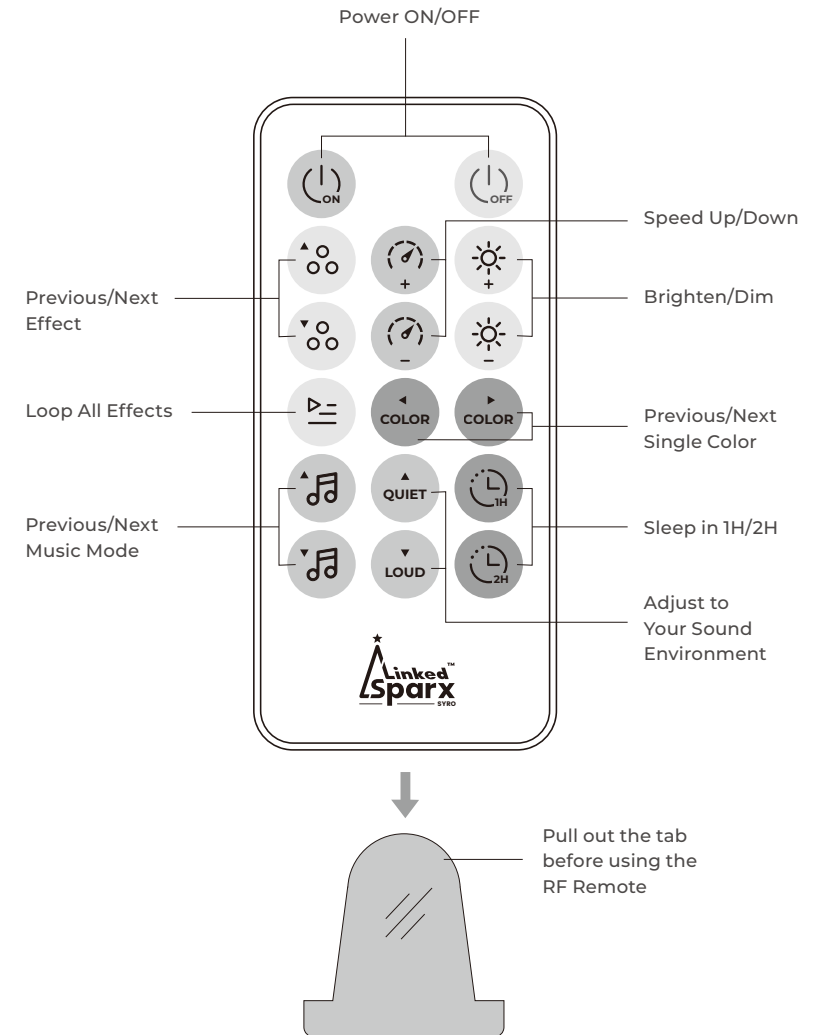

App Download



Please scan the QR code to download the 'LEDSMART' App.



*This application requires iOS 10.0 or later / Android 4.4 or later.

1. Download and install the "LEDSMART" App.
2. Go to 'Settings' of your mobile device and turn on BT.
3. App automatically searches and lists all available SYRO devices nearby. Select your device to connect, then you can fully control SYRO-Bricks.



* Generally, you can control up to 5 devices simultaneously. This may vary from different phones.

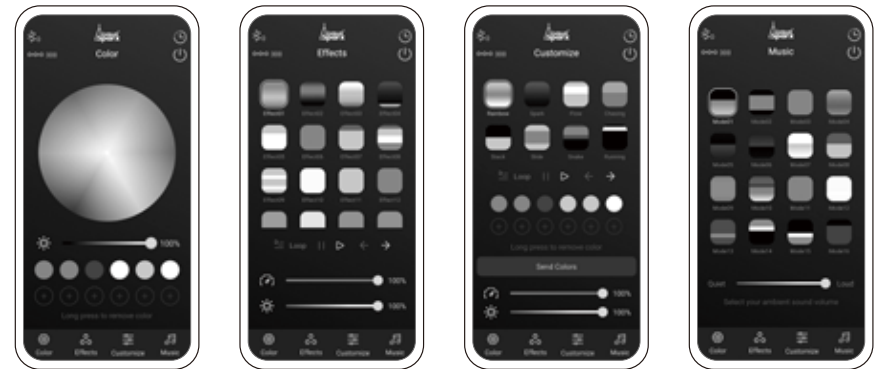

* The user interfaces provided above are for reference only, and might be different from the latest version of the App.

Online Guide

For more detailed features about the App, please visit www.linkedsparx.com/syro-app

MUST READ Before Installation

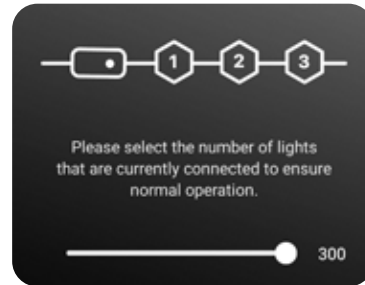
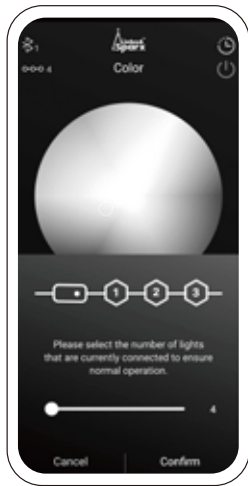

To accurately perform all light effects on your layout, our App lets you decide the sequence number of modules you wish to control or multiply.

How to count the sequence number of light modules

If you connect 2 or up to 5 modules to the previous module, these newly connected (next-tier) modules will receive the same command from the previous one, therefore display same and synchronized effect.

You need to count the number of modules connected in the longest line. As you can see from the example below, you should set the sequence number as 4.

The sequence number you set should either be the same or less than the number of all connected modules.

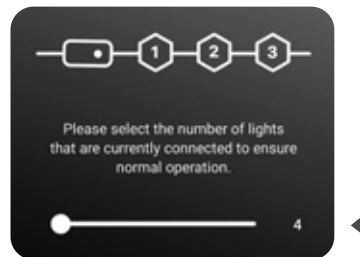
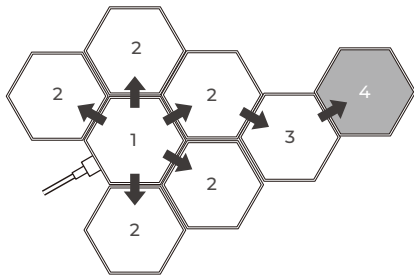

How to multiply light effect

It is also possible to set a small number than your actual setup. The App can automatically duplicate effects for the following segments.

For example, if you have 10 modules connected in a line and set the number as 5, the 2 segments of modules will play the same effect.

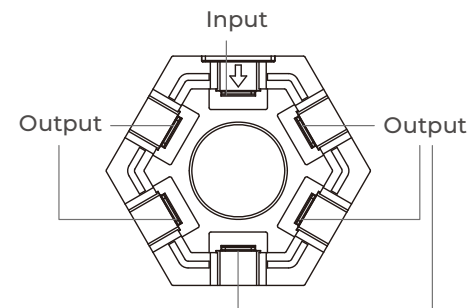
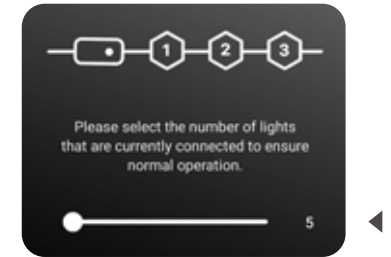

Each hexagonal module has 1 input and 5 outputs. You can easily find the input with an arrow ↓ mark on it.

Please always plug the power + signal incoming source into the input. Be aware that improper connections could cause malfunction, such as modules not lighting up or uncontrollable.

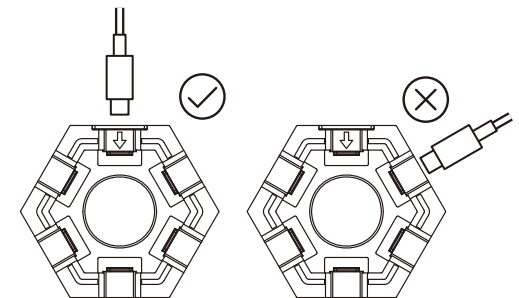

How to Create Your Own SYRO-Bricks Layout

1. Display on Stands

Firstly create your layout on a flat surface and designate a module as the starting module.

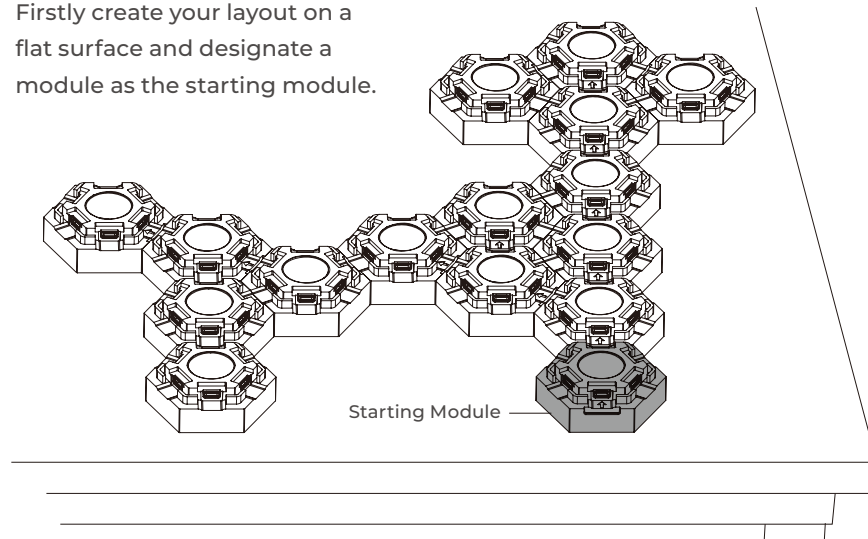

When you are satisfied with your layout, attach connectors between modules.

*There are 16 connectors in the package, 1 spare included.

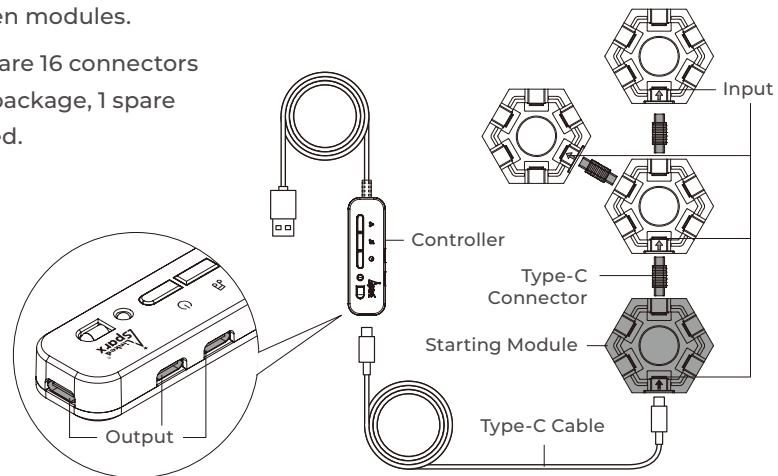

⚠ Please DO NOT use all connectors to form a closed-circuit that may cause malfunctions.

Example 1

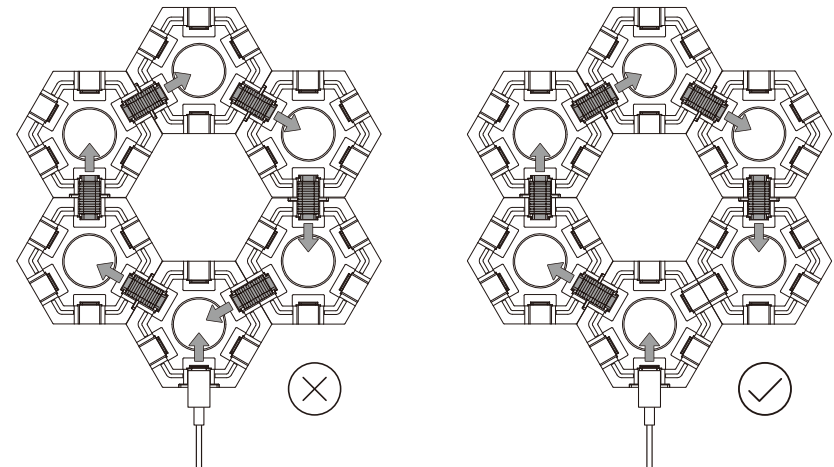

Example 2

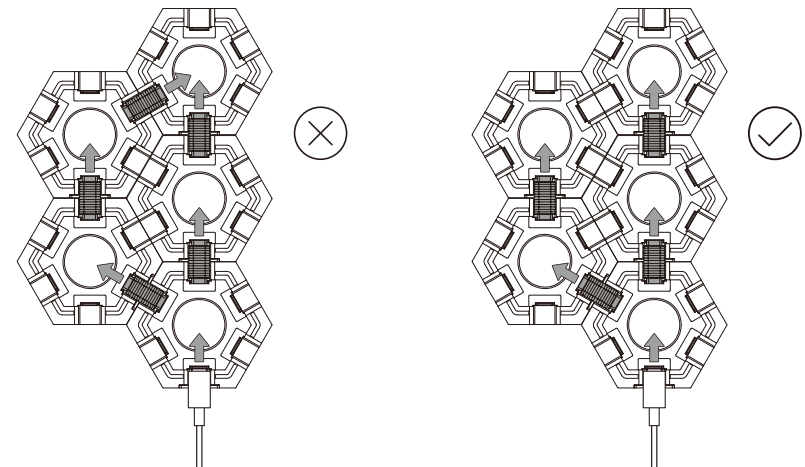

Then use a Type-C cable to connect the controller to the starting module.

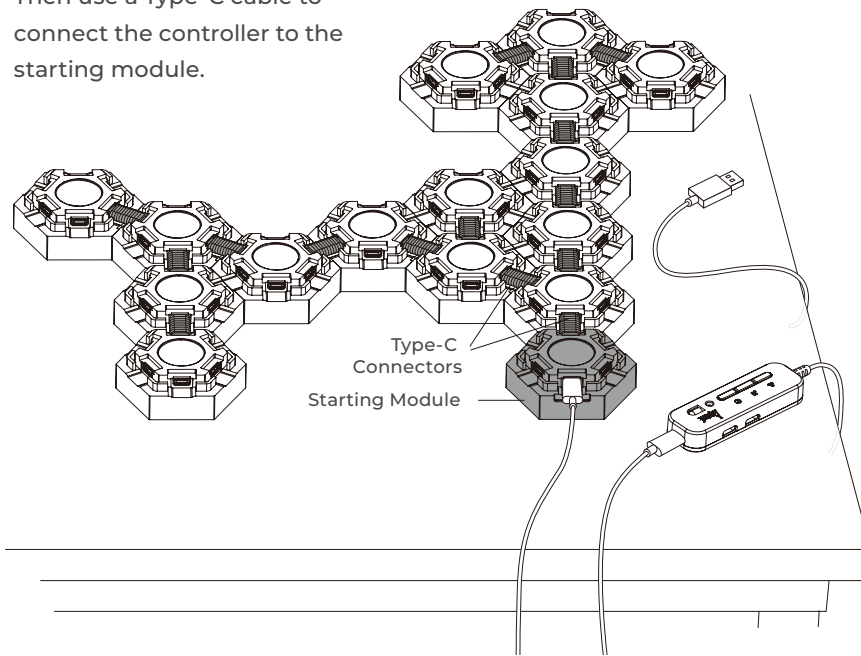

- ⚠ If no modules light up, please check if the controller and the power adapter are connected properly.
- ⚠ If certain modules DO NOT light up, please make sure you connect the input and output between modules correctly.

⚠ A power supply with 5V 2A output can carry 50 modules.
 If you wish to connect more than 50 modules, you can plug a charger or power bank with a Type-C port into any output port of a module to provide extra power supply.
 Theoretically speaking, you may extend your layout to up to 300 modules in a single line with enough power supply.

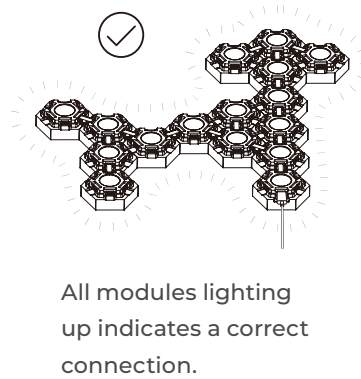
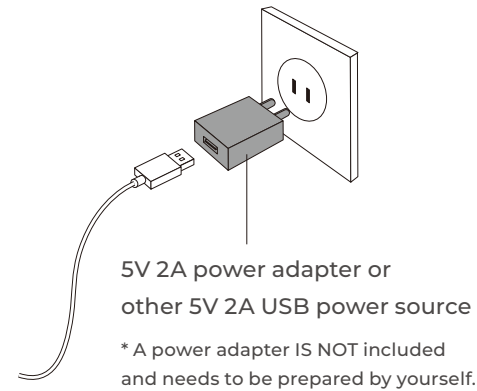

If function normally, you could place fixtures on all connectors to fasten them. It can prevent connected modules from bending and avoid any damage to the product.

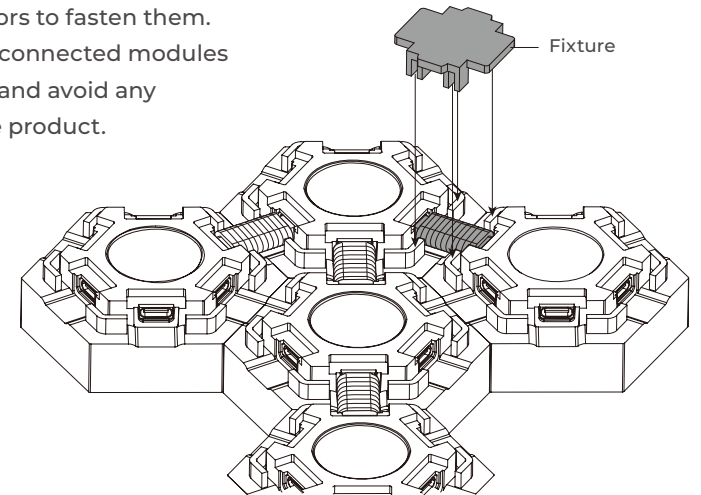

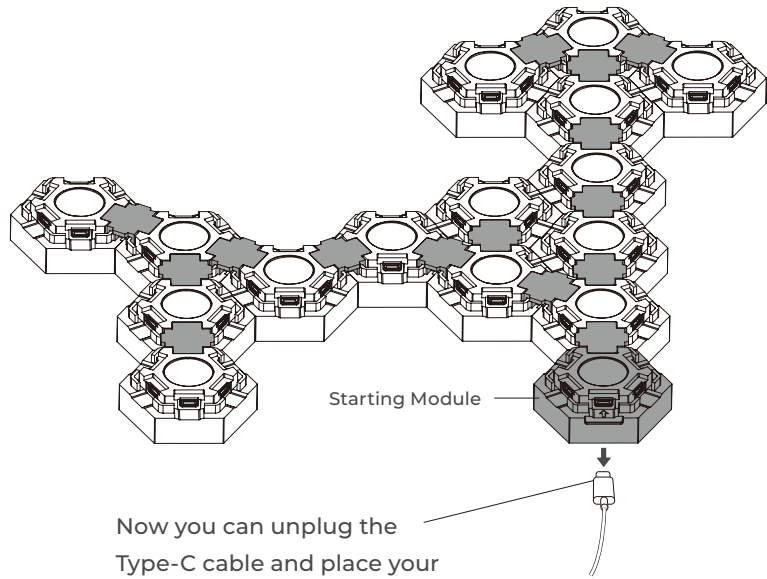

Now you can unplug the Type-C cable and place your layout on the Stand.

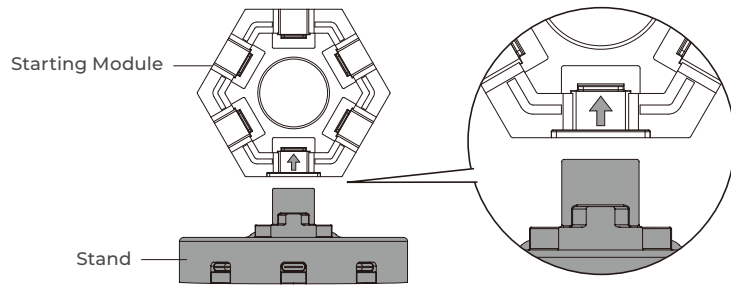

SYRO-Bricks Starter Kit comes with 2 stands. Please make sure the input port of the starting module is facing downwards and plug it into the stand.

It is recommended to move the bottom of your layout to the edge of desktop, and then install the stands.

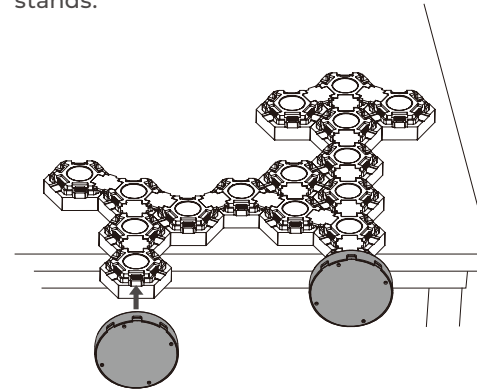

Plug into the other stand as support, now you can carefully put your creation upright.

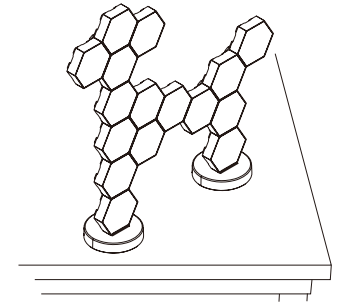

Plug the Type-C cable with controller into any slot of the first stand and power on. You are ready to explore all the cool features of Syro-Bricks!

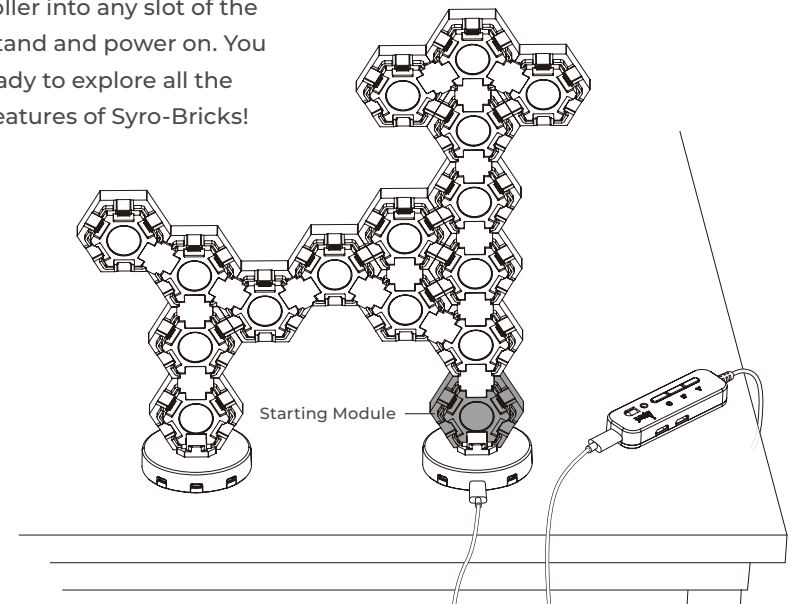

How to Unfasten the Fixture

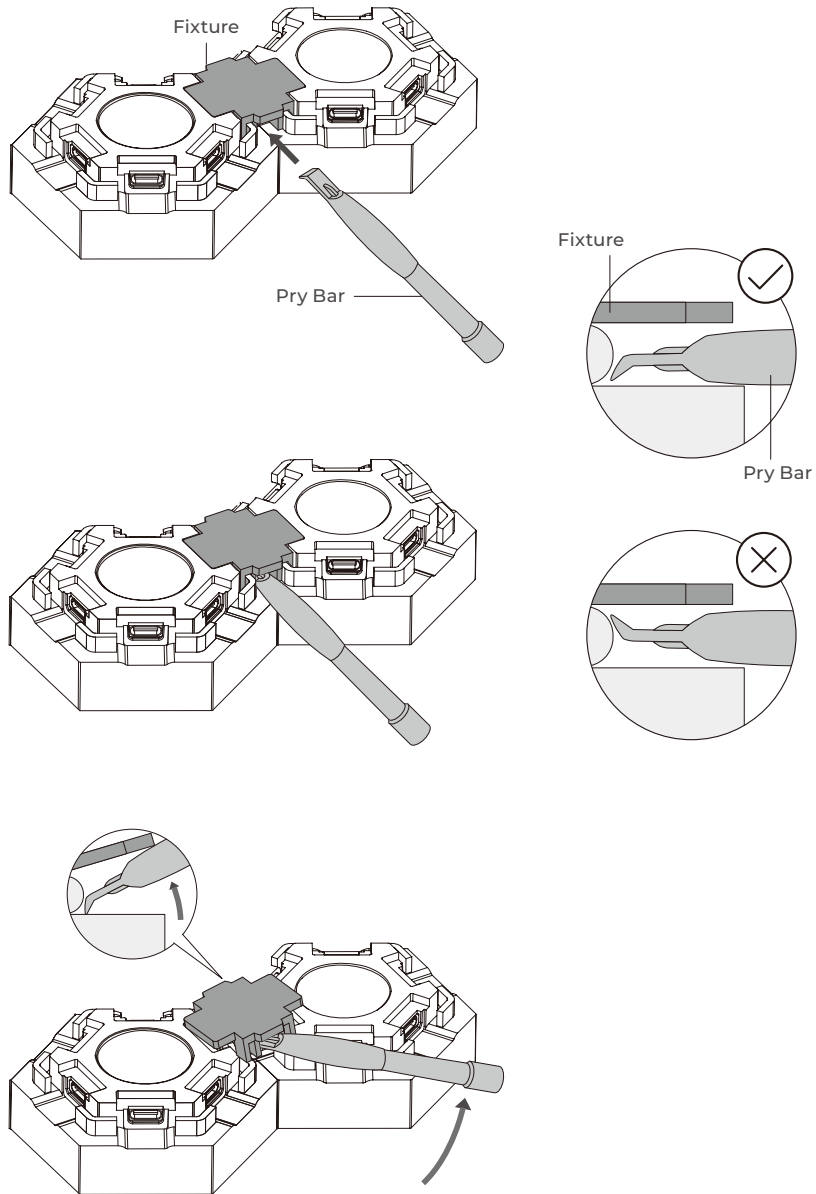

Advanced: 3 Ways of Connecting to Stands

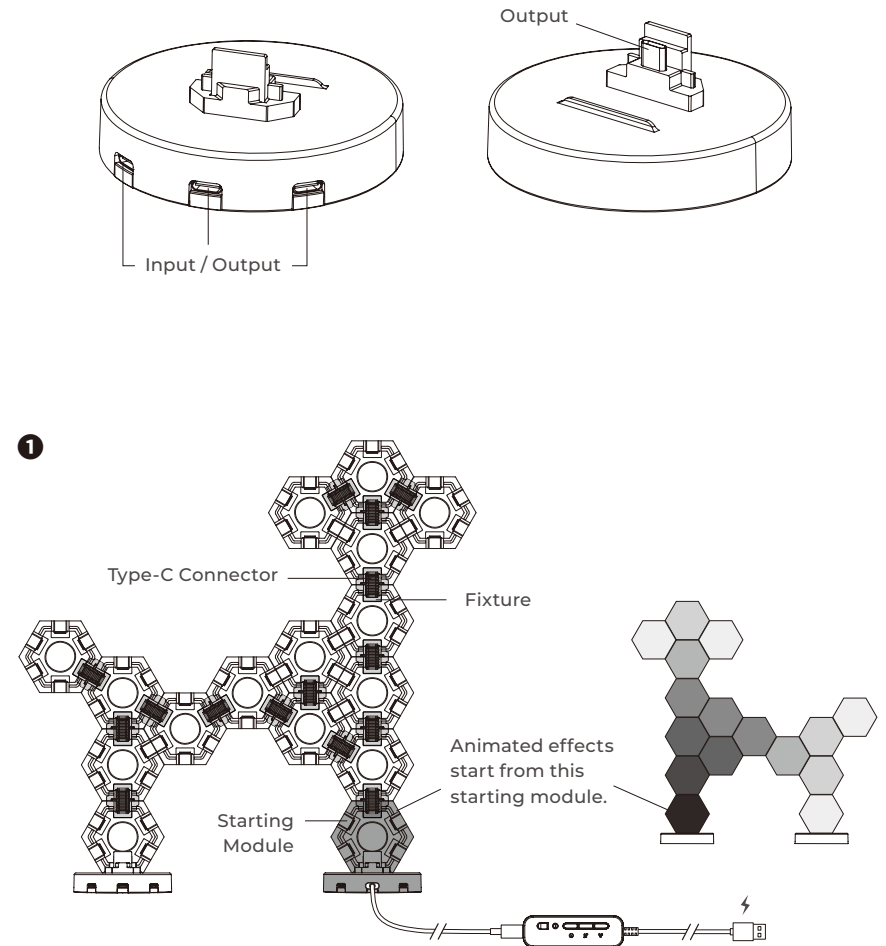

You can use the 2nd stand simply as a support. No cable is required to plug into the 2nd stand. Just make sure that all light modules are properly connected to the 1st stand.

2

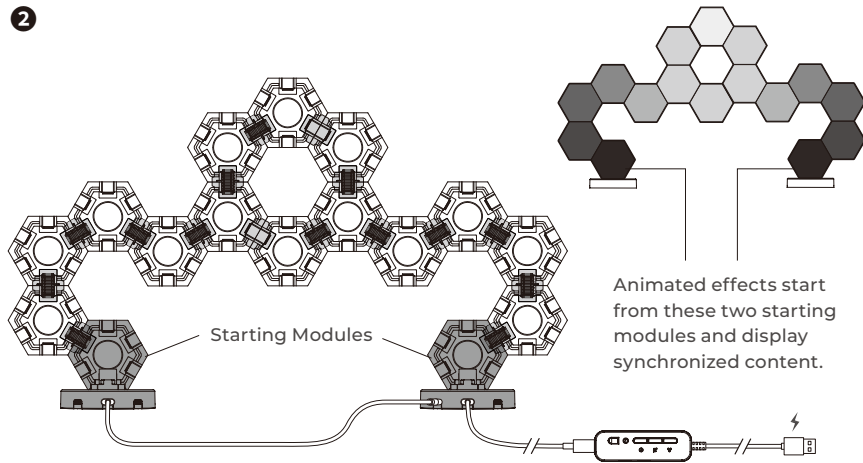

If you wish to create a symmetrical layout, it is recommended to start building from 2 starting modules, and divide all modules into 2 groups. Link the 2nd stands with the additional Type-C cable, then these 2 groups of modules will display synchronized effects.

3

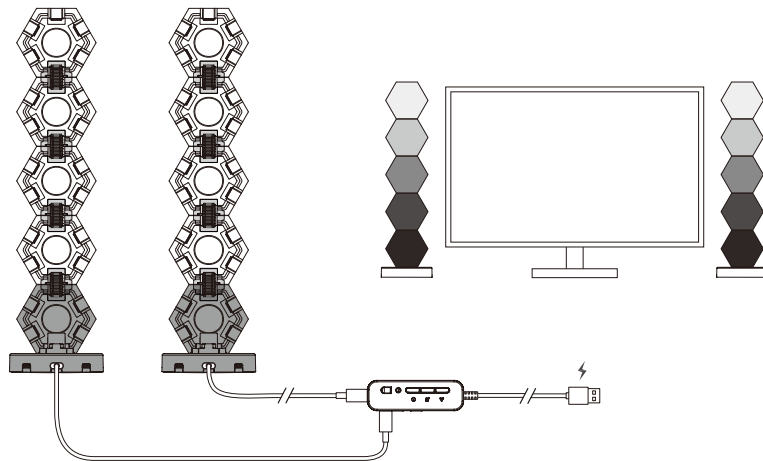

With 3 outputs on the controller, you can also connect the 2 physically independent groups of modules directly to the controller. You will achieve the same synchronized effects as 2

2.Wall Display

Firstly create your layout on a flat surface and designate a module as the starting module. When you are satisfied with your layout, attach connectors between modules and connect to the controller and power source. Then power on to check if all modules are properly connected.

* Please refer to page 9-11 for detailed steps.

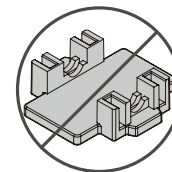
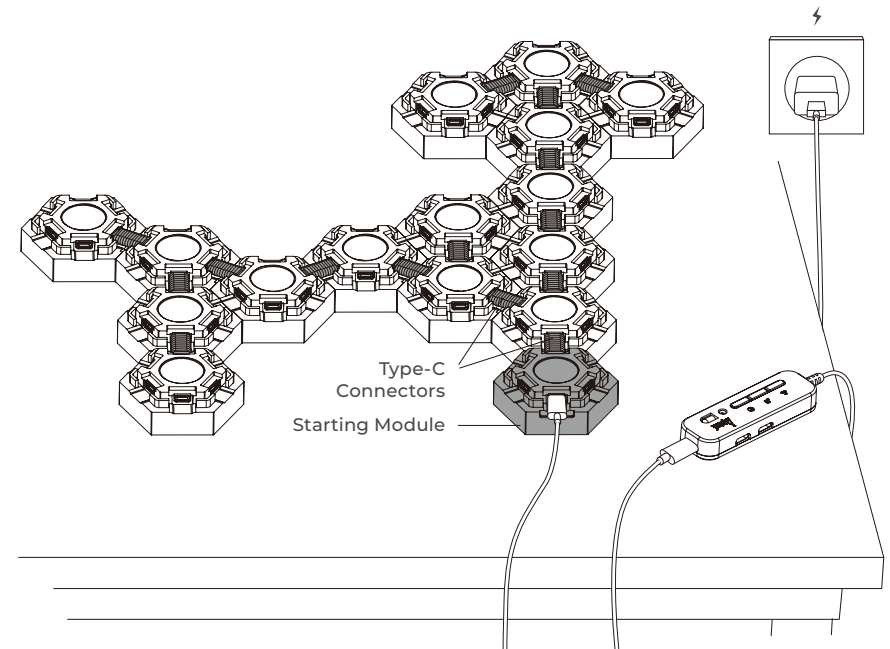

You won't be needing any fixtures for wall display.

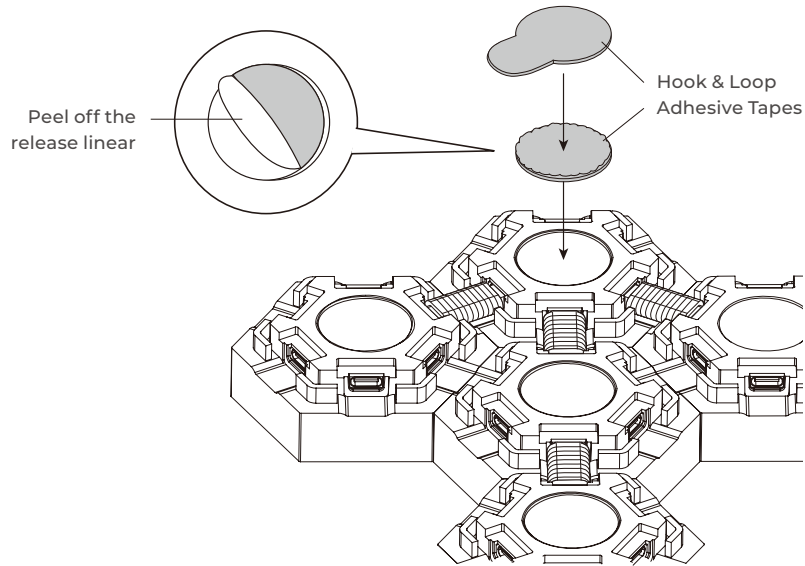

Considering that you might want to change your layout and get it off the wall anytime, we suggest you not put adhesive tapes on the back of every module.

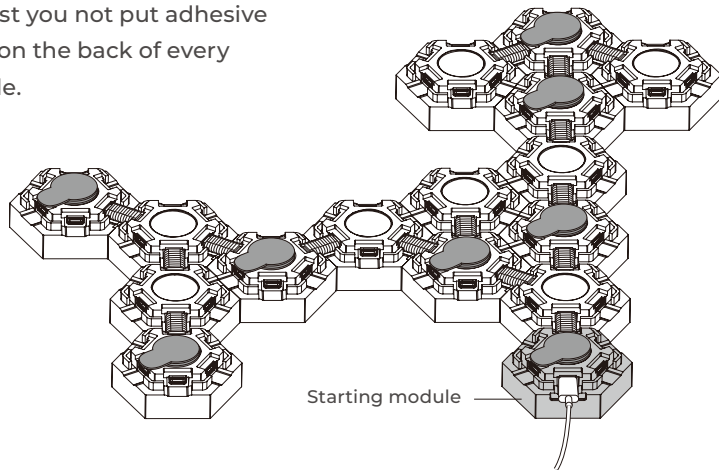

Find the supporting points of your layout and put tapes on these modules. Every 3 modules should at least have 1 module with tapes on the back.

WARNING!

The light modules should be installed on a clean, flat, and smooth surface. The adhesive tape is NOT recommended for wallpaper, brick walls, moist, or dusty walls.

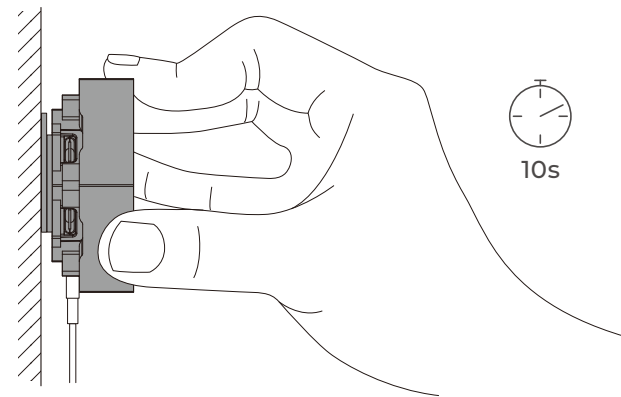
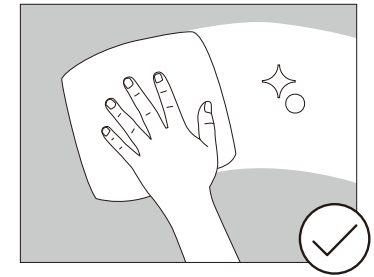
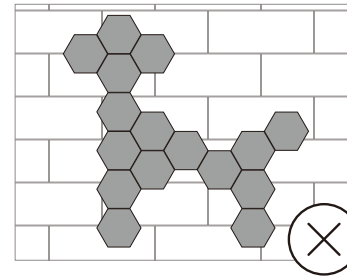

Begin with the starting module with controller while powered on: Peel off the release linear from tape. Position the module on wall, and apply strong pressure to the center for more than 10 seconds to better adhere.

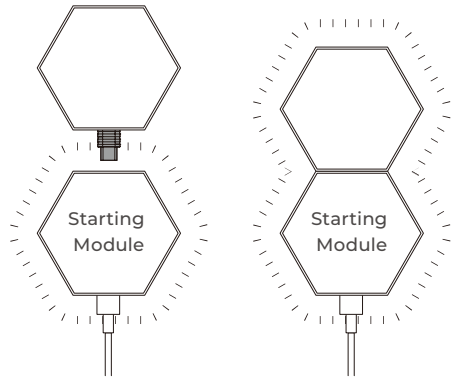

Attach a connector to the next module's input and peel off the tape linear. Plug it into the previous module and then press it onto the wall. Make sure that the newly connected module light up and is aligned edge to edge.

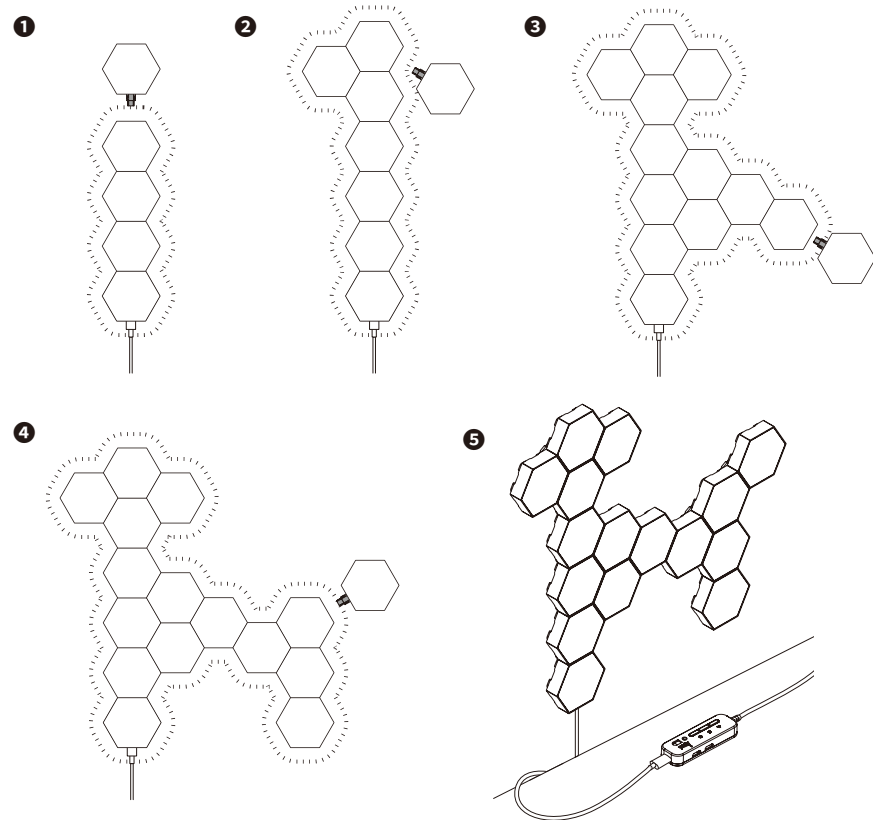

Advanced: Connect Multiple Groups of Modules

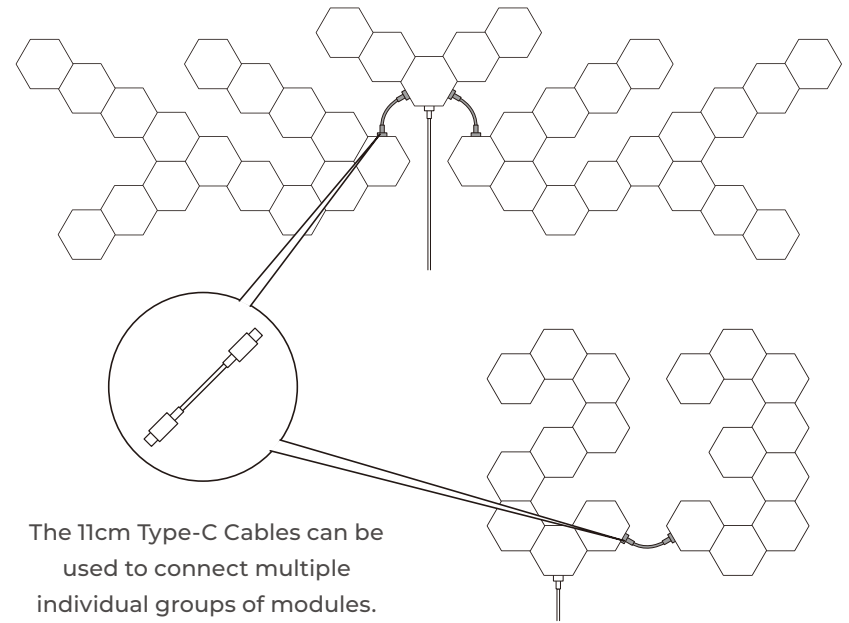

The 11cm Type-C Cables can be used to connect multiple individual groups of modules.

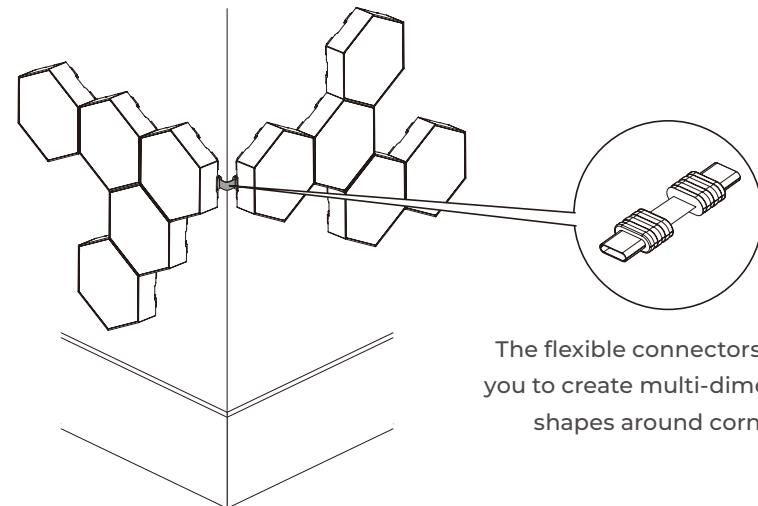

The flexible connectors enable you to create multi-dimensional shapes around corners.

How to Remove Your Layout from Wall

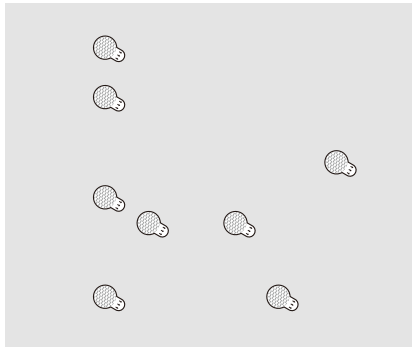

Take off your modules one by one or group by group from the wall. One side of the hook & loop tape will remain on the wall.



With one hand pressing on the tape, use your other hand to pull the sticking-out end along the wall until it is fully removed.

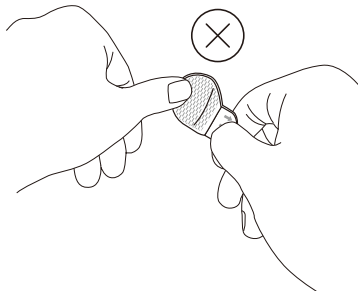

Do not lift or pull from other angles to avoid damage to your wall.



Paint Your Idea