



## About us

LinkedSparx is a LED lighting technology company that strives to push the boundaries of smart LED technology and transform ordinary home lighting experiences into more innovative ones. Smart products should provide personalized options for different types of users, while effortlessly creating an enjoyable experience that suits their needs. With this philosophy, we constantly explore the balance between the application of new technologies and user experience, and have launched a series of smart holiday decorative lights, desktop ambient lights, and other products.



## Contacts

Shenzhen LinkedSparx Technology Co., Ltd

606, 82, 4th Industrial Park, Tantau Community, Songgang,  
Bao'an District, Shenzhen, CHINA 518100

Email: [business@linkedsparx.com](mailto:business@linkedsparx.com) / [patricia@linkedsparx.com](mailto:patricia@linkedsparx.com)

Tel: +86-138 2316 9580 / +86-137 2376 0911



[www.linkedsparx.com](http://www.linkedsparx.com)

[www.linkedsparx.com](http://www.linkedsparx.com)

16 PCs RGB

App-Controlled Light Modules



Light Up Your Words

# SYRO - The Box

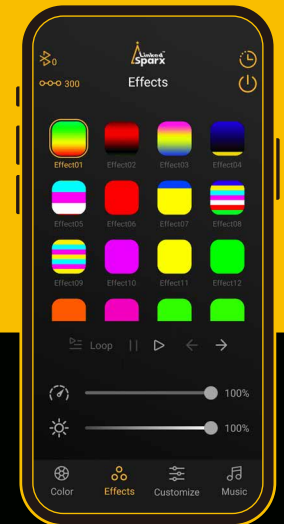



# Living Room Ambience





# Gaming Room Setup

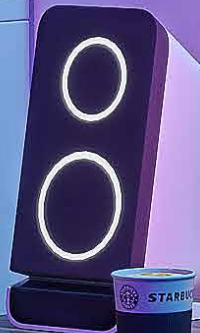



# Entertainment Space Decor

ROCK  
AND  
ROLL

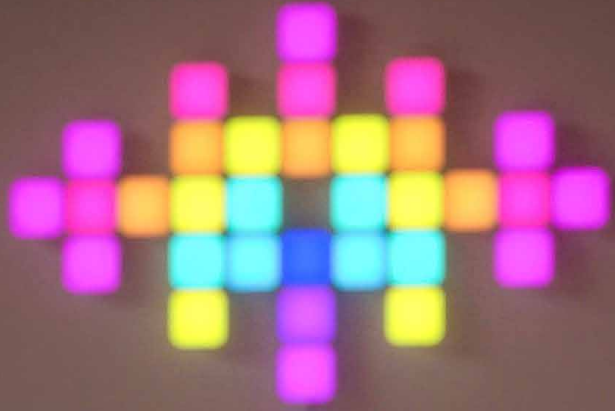



# Office Desktop Display



THINK BIG

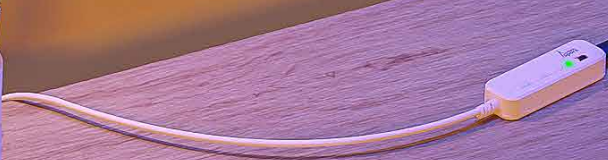
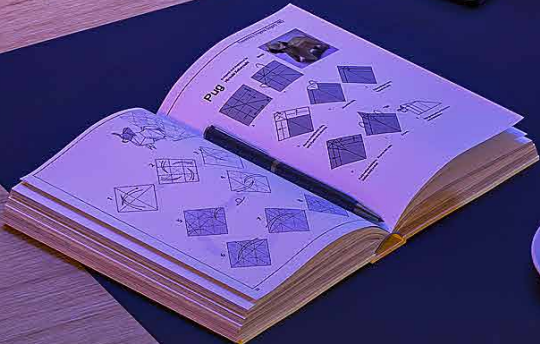



# Party Decoration





# Night Lamp



RELAXED







## PIXEL ART SHAPES

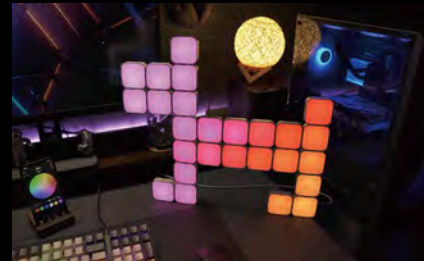

## FROM 2D TO 3D: THE EVOLUTION OF AMBIENCE LIGHTING



## Text & Numbers



# Illuminate Creativity, Brighten Young Minds







Changable  
Slides



Various  
Combinations



App & Remote  
Controlled



Indoor Use



Sync with Music



Timer Mode

# Video Guide

(Click to Watch)

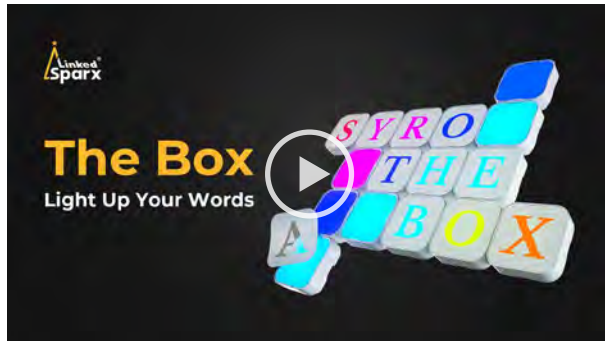

Advertising Video

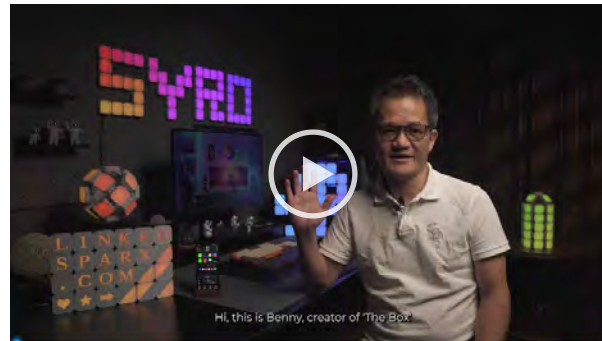

Product Introduction



Music modes



# The Box Modules

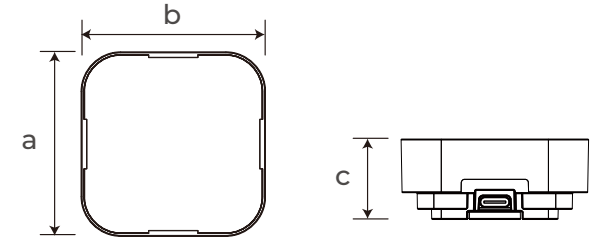
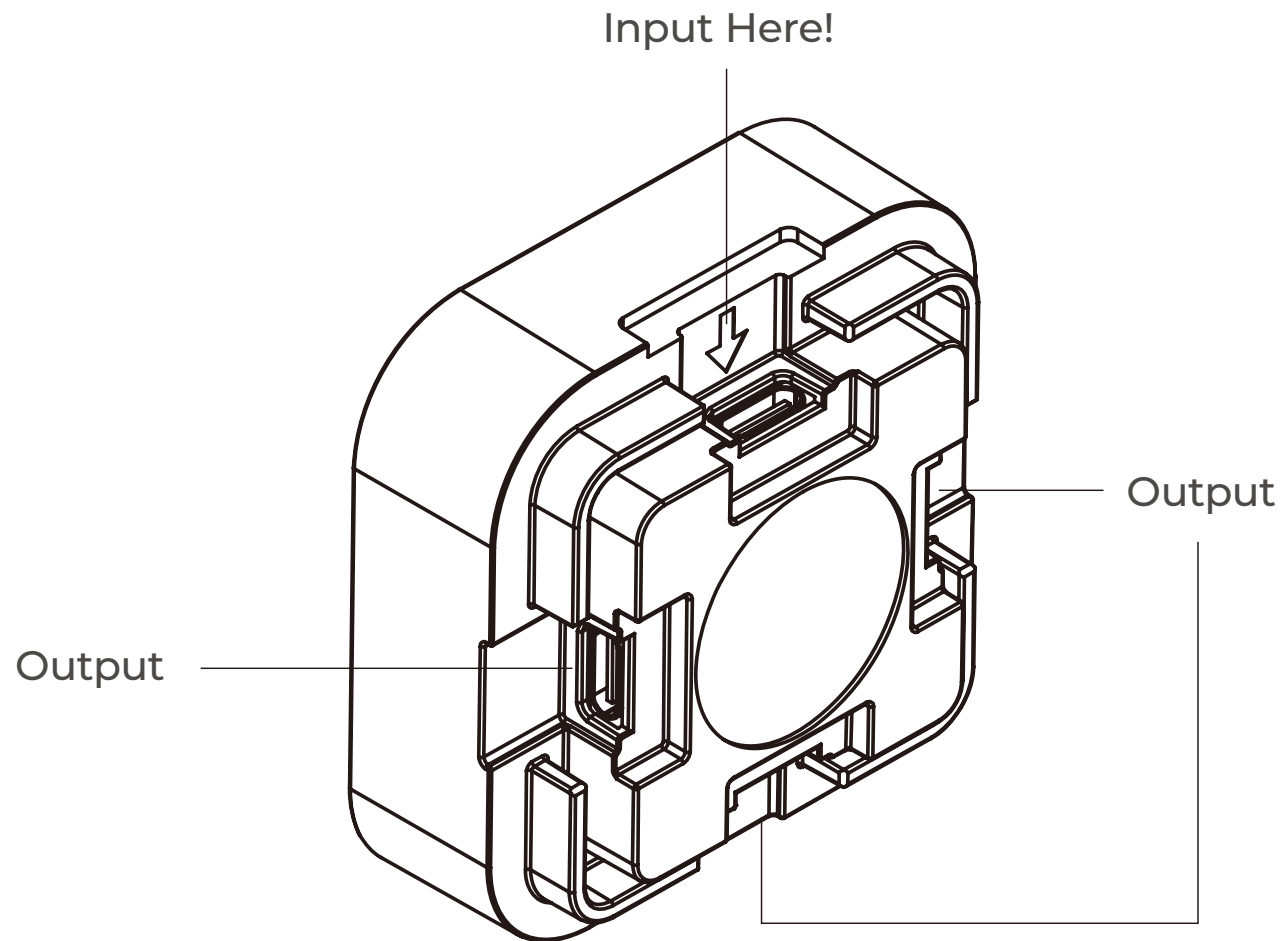

Module Dimensions	
a	5.6cm / 2.2in
b	5.6cm / 2.2in
c	2.4cm / 0.94in

LED Color: RGB / White

Connectivity: BT

Working Voltage: 5V/2A

Max Panels Per PSU  $\approx$  100

Max Panels Per Controller on a route: 300

Materials: Fireproof Polycarbonate & ABS

Operating Temperature:  $-5\sim 45^{\circ}\text{C}$

Life Span: More than 20,000 hours



# What's in the Box?

RGB 



- ① Square Modules x 16
- ② Controller x 1
- ③ Type-C Cables x 2
- ④ IR Remote x 1
- ⑤ Pry Bar x 1
- ⑥ Mounting Tapes x 10
- ⑦ L-Bases x 2
- ⑧ Slides x 60
- ⑨ Fixtures x 16
- ⑩ 6cm Type-C Flexible Connectors x 2
- ⑪ Connectors x 16

✂ \*Power adapter not included.

The Box Holiday Kit 16pcs (White)



- ① Square Modules x 16
- ② Controller x 1
- ③ Type-C Cables x 2
- ④ IR Remote x 1
- ⑤ Pry Bar x 1
- ⑥ Mounting Tapes x 10
- ⑦ L-Bases x 2
- ⑧ Slides x 60
- ⑨ Fixtures x 16
- ⑩ 6cm Type-C Flexible Connectors x 2
- ⑪ Connectors x 16

✂ \*Power adapter not included.

The Box Holiday Kit 16pcs (Black)





- 1 Square Modules x 24
- 2 Controller x 1
- 3 Type-C Cables x 3
- 4 IR Remote x 1
- 5 Pry Bar x 1
- 6 Mounting Tapes x 20
- 7 L-Bases x 4
- 8 Slides x 120
- 9 Angled Fixtures x 26
- 10 Fixtures x 24
- 11 Flexible Connectors x 26
- 12 6cm Type-C Flexible Connectors x 4
- 13 Connectors x 24
- \*Power adapter not included.

The Box 3D Kit 24pcs (White)



- 1 Square Modules x 24
- 2 Controller x 1
- 3 Type-C Cables x 3
- 4 IR Remote x 1
- 5 Pry Bar x 1
- 6 Mounting Tapes x 20
- 7 L-Bases x 4
- 8 Slides x 120
- 9 Angled Fixtures x 26
- 10 Fixtures x 24
- 11 Flexible Connectors x 26
- 12 6cm Type-C Flexible Connectors x 4
- 13 Connectors x 24
- \*Power adapter not included.

The Box 8pcs (Black)

WHITE LIGHT ○



- ① Square Modules x 16
  - ② Controller x 1
  - ③ Type-C Cables x 2
  - ④ RF Remote x 1
  - ⑤ Pry Bar x 1
  - ⑥ Mounting Tapes x 10
  - ⑦ L-Bases x 2
  - ⑧ Slides x 60
  - ⑨ Fixtures x 16
  - ⑩ 6cm Type-C Flexible Connectors x 2
  - ⑪ Connectors x 16
- ✂ \*Power adapter not included.

The Box White Light 16pcs (White/Black) ○ ■



- ① Square Modules x 9
  - ② Controller x 1
  - ③ 1m USB-C Cable x 1
  - ④ RF Remote x 1
  - ⑤ Pry Bar x 1
  - ⑥ Mounting Tapes x 5
  - ⑦ L-Bases x 2
  - ⑧ Slides x 60
  - ⑨ Fixtures x 9
  - ⑩ Connectors x 9
- ✂ \*Power adapter not included.

The Box White Light 9pcs (White/Black) ○ ■



# Changeable Slides

Can be customized according to your needs

## Slides Expansion (White) - 80pcs



A	B	C	D	E	J	K	Q	V	X	:	'	-	←	♥					
F	G	H	I	L	Z	A	E	R	.	○	△	□	×	★					
M	N	O	P	R	1	2	3	4	5	#	@	&	\$	€					
S	T	U	W	Y	6	7	8	9	0	£	?	!	/	%					

## Slides Expansion (Black) - 80pcs



A	B	C	D	E	J	K	Q	V	X	:	'	-	←	♥					
F	G	H	I	L	Z	A	E	R	.	○	△	□	×	★					
M	N	O	P	R	1	2	3	4	5	#	@	&	\$	€					
S	T	U	W	Y	6	7	8	9	0	£	?	!	/	%					

# SYRO-Bricks

More Pieces More Fun



3D Installation



Various  
Combinations



App & Remote  
Controlled



Sync with Music



Timer Mode



Indoor Use





## CREATE UNIQUE LAYOUTS

From a tower to a cute puppy, and lots more possibilities, your creativity with SYRO-Bricks is encouraged

Extendable up to 1000 bricks with extra power input



## 2D & 3D INSTALLATION

SYRO-Bricks innovatively turned traditional 2D installation into 3D structure with meticulously engineered flexible connectors and fixtures





Kidsroom Night Lamp

# DECORATE YOUR SPACE HOWEVER YOU WANT

Display your SYRO-Bricks on stands or attach them onto the wall. Excellent gift choice for friends & family to decorate gaming room, living room, bedroom, etc.



Gaming Room Setup



Entertainment Space Decor



Living Room Ambiance

**SYRO-Bricks Trailer**



Scan to watch video

**What Made SYRO-Bricks Special**



Scan to watch video

SYRO-Bricks: Smart 3D Customizable Hexagon Light Panels



Our Successful Campaign on  
**KICKSTARTER**  
**122% Funded**



Scan to see more details

## SPECIFICATIONS

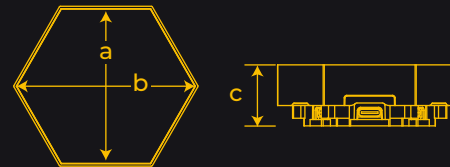

Module Dimensions	
a	6.29cm / 2.48in
b	7.25cm / 2.85in
c	2.4cm / 0.94in

- Color: RGB 16 million colors
- Connectivity: Bluetooth
- Working Voltage: 5V/2A
- Max Panels Per PSU  $\approx$  100
- Max Panels Per Controller on a route: 300
- Materials: Fireproof Polycarbonate & ABS
- Operating Temperature: -5~45°C
- Life Span: More than 20,000 hours





# Office Desktop Display





# Entertainment Space Decor

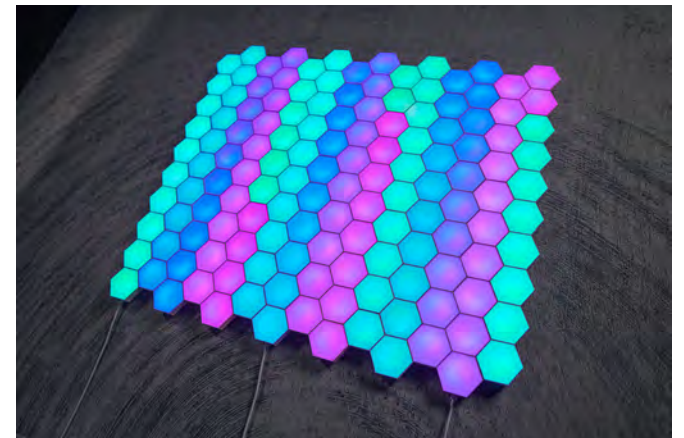



# Living Room Ambience

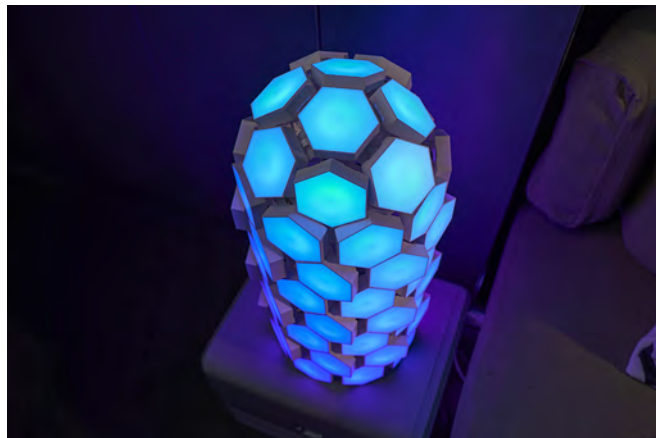





3D

3D Installation



Various  
Combinations



App & Remote  
Controlled



Indoor Use



Sync with Music



Timer Mode



## Video Guide

(Click to Watch)

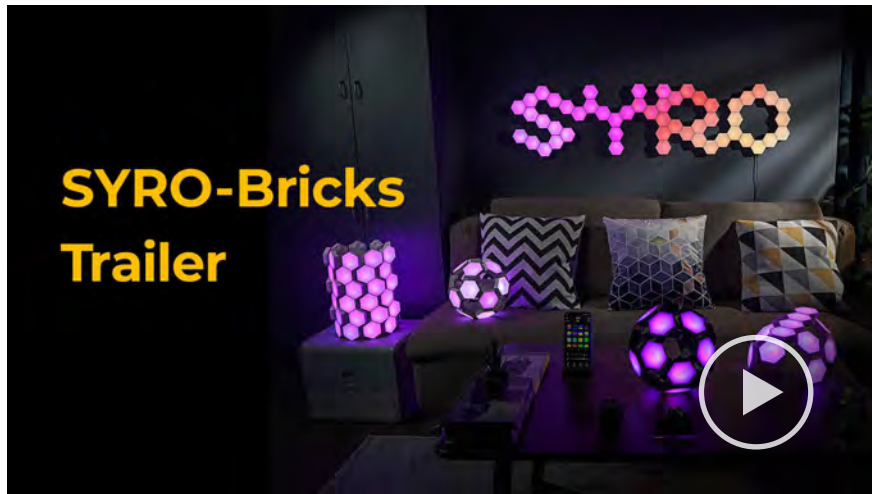

# What's in the Box?



- ① Hexagonal Modules x 8
- ② Controller x 1
- ③ Type-C Cables x 2
- ⚡ \*Power adapter not included.
- ④ RF Remote x 1
- ⑤ Pry Bar x 1
- ⑥ Mounting Tapes x 5
- ⑦ Fixtures x 8
- ⑧ Connectors x 8
- ⑨ L-Bases x 2

**SYRO-Bricks 8pcs (White)**



- ① Hexagonal Modules x 16
- ② Stands x 2
- ③ Controller x 1
- ④ Type-C Cables x 3
- ⑤ RF Remote x 1
- ⑥ Pry Bar x 1
- ⑦ Mounting Tapes x 10
- ⑧ Fixtures x 16
- ⑨ Flexible Connectors x 1
- ⑩ Connectors x 16
- ⚡ \*Power adapter not included.

**SYRO-Bricks Starter Kit 16pcs(White)**





- 1 Hexagonal Modules x 20
- 2 Controller x 1
- 3 Type-C Cables x 2
- 4 RF Remote x 1
- 5 Pry Bar x 1
- 6 Mounting Tapes x 10
- 7 Angled Fixtures x 30
- 8 Fixtures x 20
- 9 Flexible Connectors x 22
- 10 Coonectors x 20
- \*Power adapter not included.

**SYRO-Bricks Dyson Sphere Kit 20pcs (Black)**



- 1 Hexagonal Modules x 72+1
- 2 Stands x 3
- 3 Controller x 1
- 4 USB-C Charge Cables x 2
- 5 Type-C Cables x 7
- 6 RF Remote x 1
- 7 Pry Bar x 2
- 8 Mounting Tapes x 40
- 9 Angled Fixtures x 40
- 10 Fixtures x 74
- 11 Flexible Connectors x 24
- 12 Connectors x 74
- \*Power adapter not included.

**SYRO-Bricks Ultimate Kit 72pcs (White)**

# PERSONALIZE YOUR RGB SCENES

Select & play from effect gallery, or choose from 16 million colors to customize your color scenes based on 8 patterns. Set the right vibe for your mood



Download on the  
App Store

GET IT ON  
Google Play



RGB 16 million  
colours

26+16  
Effects Music Modes

An abundant effect  
gallery



Adjust brightness  
and speed



Set Timer to turn off/on  
by schedule



# 3 WAYS OF CONTROL

RF Remote + Button + App



# PVC String

Various shapes & specifications can be customized



Extendable



App & Remote  
Controlled



Sync with Music



Timer Mode



Waterproof  
IP65

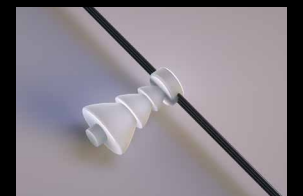
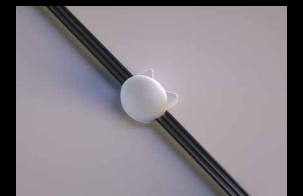
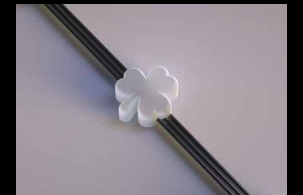



# String Lights

Easy to Be Smart



App Controlled



No Pairing Needed



Sync with Music



Timer Mode



10+5

Effects Music Modes

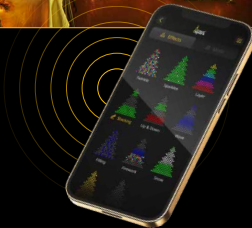

## TRADITIONAL STRING



Model	LS-S210-2A	LS-S300-2A	LS-S420-2A
LED Qty.	210	300	420
Lighted Length	54.9ft / 16.7m	78.5ft / 23.9m	110ft / 33.5m

## MOLDED PVC STRING

Various shapes & specifications can be customized

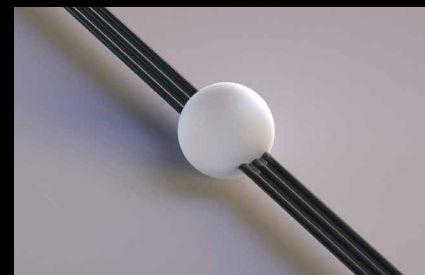

Model	LS-P250-2A	LS-P300-2A	LS-P400-2A
LED Qty.	250	300	400
Lighted Length	82ft / 25m	98.4ft / 30m	105ft / 32m

# Product Details

**Item name:** LinkedSparx Smart LED Indoor String Lights

**Model ID:** LS-S420-2A, LS-S300-2A, LS-S210-2A

**Introduction:** LinkedSparx String is a set of smart RGB LED string lights complete with the music sync feature for a festive, joyful lighting experience. Apart from various default effects previously stored in the controller that can be accessed by pressing the button, the LinkedSparx App allows you to control your string lights remotely and effortlessly. It gives you endless creative possibilities by offering numerous playful features including customizing colour schemes, adjusting brightness, setting a timer, etc.

## Features

1. No pairing setup needed: The communication protocol we adopt for our product is Beacon (Bluetooth Low Energy). After installing our App, users just need to turn on the Bluetooth on mobile devices and they are ready to go, playing around with all features.
2. Multiple users controllable: Bypassing the one-on-one pairing procedure, multiple users are able to control the lights via App at the same time. Vice versa, one mobile device can control multiple strings simultaneously.
3. Music Sync feature with built-in mic: This is a straightforward feature achieved with a built-in microphone on the controller, no extra music dongle is needed to see the lights come to life and dance to rhythm. 3 levels of microphone sensitivity are available for users to select, according to their loud or quiet surrounding sounds, to achieve best lighting experience when in music modes.
4. User-friendly for all age: Via the physical button on the controller, users can switch effect, activate Music function or Loop function. Via the app, users can get creative with playful but not complicated features, for example, directly select and play from effect gallery, advanced options like color editing, speed and brightness adjusting, timer setting, etc.
5. Abundant effect gallery: 10 default effects + 5 music modes for users to select and play at fingertips.
6. Real-time simulation: The 3D Christmas tree model on the App gives users the ability to edit and preview all the effects from the gallery realistically, so they can fully try it out before the purchase of string.

### 'LinkedSparx' App Download:

**Google Play Store:** <https://play.google.com/store/apps/details?id=com.Linkedspar.Linkedspar>

**iOS App Store:** <https://apps.apple.com/us/app/linkedsparx/id1625834337>





### Ideal distance to control the lights via App:

Generally, users can control the string lights within 10 metres without obstructions in between. The distance varies from different phones. For best performance, we suggest users keep the distance below 5 metres.

There is a low probability that the product will be interfered by other Bluetooth devices, which may cause signal loss that would affect the performance of certain effects, or even no response. Therefore users might need to click multiple times on App to send signals again.

## Certifications



# Video Guide

(Click to Watch)



General Introduction



App User Guide



Music Modes

## FOLDABLE LIT TREE



Model	LS-P60-2A	LS-P100-2A
LED Qty.	60	100
Height	1.2m	1.5m

## NET LIGHTS

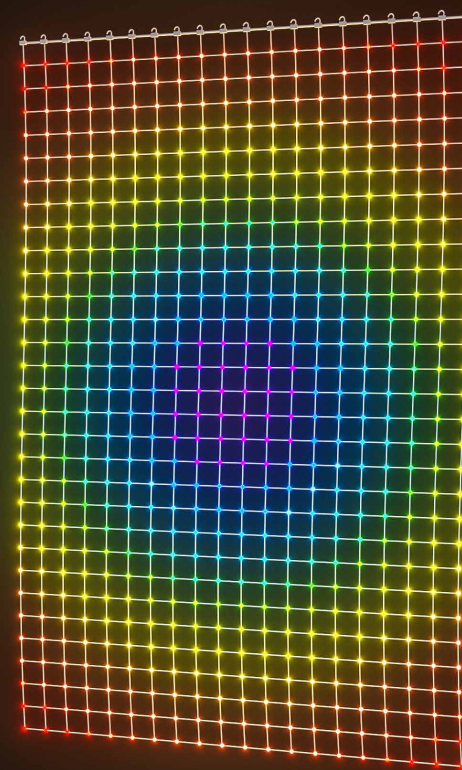

Model	LS-C600-1A
LED Qty.	600(20*30)
Height	1.3m*2m



# PORTABLE CAMPING LIGHT

LED Tape Lights, Flexible and Durable

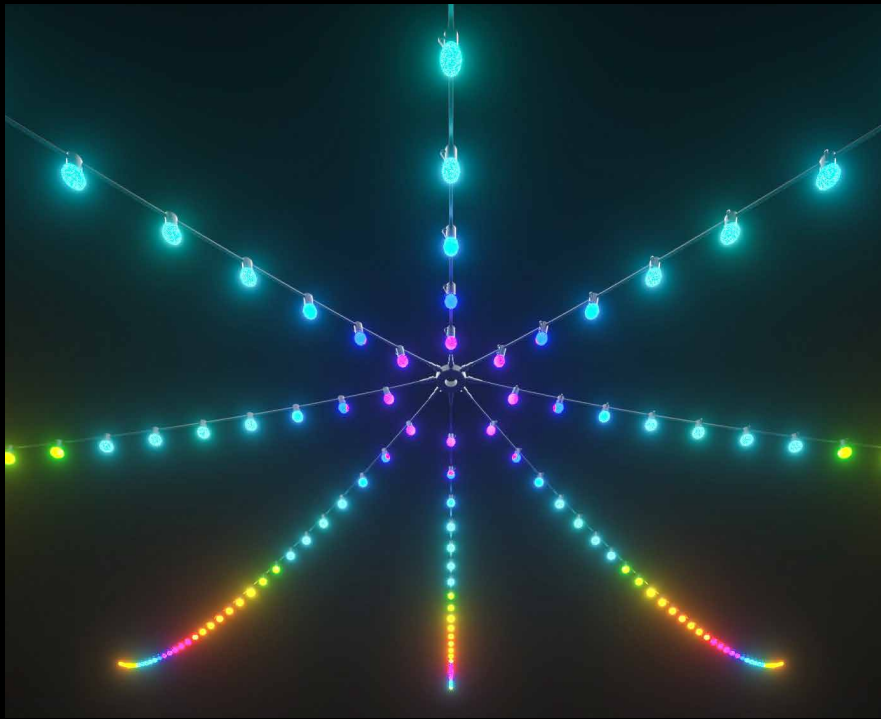

  
10m String  
Lights

  
360°  
Luminous

  
Great  
Durability

- Tent or Camping Light
- Flexible & Multifunctional
- IP67 String Lights



## LIGHT BULB STRING

Various shapes & specifications can be customized

Multiple shapes of bubbles to choose

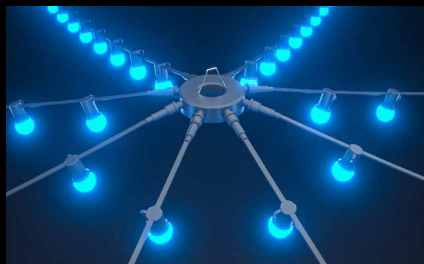

Easy and fast to  
roll up and avoid  
tangling



Model	LS-N1-1A	LS-N2-1A	LS-N3-1A
LED Qty.	96(12*8)	96(12*8)	96(12*8)
Size	1.8M*8	3M*8	6M*8